

Model GX10/GX20/GP10/GP20/GM10

**SLMP Communication (/E4)
User's Manual**

Introduction

Thank you for purchasing the SMARTDAC+ GX10/GP10/GX20/GP20/GM10 (hereafter referred to as the GX, GP, or GM).

This manual explains the SLMP communication function (/E4 option) of the GX, GP, and GM. The GX, GP, and GM are Seamless Message Protocol (SLMP) clients. For details on SLMP servers, see the materials provided with the destination server.

Before use, familiarize yourself with SLMP communication, read this manual, and then use it correctly.

Please use this manual in conjunction with the GX, GP, or GM User's Manual (GX/GP: IM 04L51B01-01EN, GM: IM 04L55B01-01EN).

In this manual, the GX20, GP20, and GM10 standard type and large memory type are distinguished using the following notations.

- Standard type: GX20-1/GP20-1/GM10-1
- Large memory type: GX20-2/GP20-2/GM10-2

The following manuals are provided for the GX/GP/GM.

• Paper Manuals

Model	Manual Title	Manual No.	Description
GX/GP	Model GX10/GX20/GP10/GP20 Paperless Recorder First Step Guide	IM 04L51B01-02EN	Explains the basic operations of the GX/GP.
GM	Data Acquisition System GM First Step Guide	IM 04L55B01-02EN	Explains the basic operations of the GM.
GX/GP	Precaution on the use of SMARTDAC+ GM	IM 04L51B01-91EN	Provides precautions common to the SMARTDAC+ series.
	Regarding the Downloading and Installing for the Software, Manuals and Labels/ About the Usage of Open Source Software	IM 04L61B01-11EN	Explains where software applications and electronic manuals common to the SMARTDAC+ series can be downloaded from and how to install the software applications.

• Downloadable Electronic Manuals

You can download the latest manuals from the following website.

www.smartdacplus.com/manual/en/

Model	Manual Title	Manual No.	Description
GX/GP	Model GX10/GX20/GP10/GP20 Paperless Recorder First Step Guide	IM 04L51B01-02EN	This is the electronic version of the paper manual.
	Model GX10/GX20/GP10/GP20 Paperless Recorder User's Manual	IM 04L51B01-01EN	Describes how to use the GX/GP. The communication control commands and some of the options are excluded.
	Model GX10/GX20/GP10/GP20 Advanced Security Function (/AS) User's Manual	IM 04L51B01-05EN	Describes how to use the advanced security function (/AS option).
GM	GM Data Acquisition System First Step Guide	IM 04L55B01-02EN	This is the electronic version of the paper manual.
	GM Data Acquisition System User's Manual	IM 04L55B01-01EN	Describes how to use the GM. The communication control commands and some of the options are excluded.
	GM Data Acquisition System Advanced Security Function (/AS) User's Manual	IM 04L55B01-05EN	Describes how to use the advanced security function (/AS option).
GX/GP	Model GX10/GX20/GP10/GP20/GM10 Communication Commands User's Manual	IM 04L51B01-17EN	Describes how to use command control communication functions.
GM	SMARTDAC+ STANDARD Universal Viewer User's Manual	IM 04L61B01-01EN	Describes how to use Universal Viewer, which is a software that displays GX/GP/GM measurement data files.
	SMARTDAC+ STANDARD Hardware Configurator User's Manual	IM 04L61B01-02EN	Describes how to use the PC software for creating setting parameters for various GX/GP/GM functions.
	Model GX10/GX20/GP10/GP20/GM10 Multi-batch Function (/BT) User's Manual	IM 04L51B01-03EN	Describes how to use the multi-batch function (/BT option).
	Model GX10/GX20/GP10/GP20/GM10 Log Scale (/LG) User's Manual	IM 04L51B01-06EN	Describes how to use the log scale (/LG option).
	Model GX10/GX20/GP10/GP20/GM10 EtherNet/IP Communication (/E1) User's Manual	IM 04L51B01-18EN	Describes how to use the communication functions through the EtherNet/IP (/E1 option).
	Model GX10/GX20/GP10/GP20/GM10 WT Communication (/E2) User's Manual	IM 04L51B01-19EN	Describes how to use WT communication (/E2 option).
	Model GX10/GX20/GP10/GP20/GM10 OPC-UA Server (/E3) User's Manual	IM 04L51B01-20EN	Describes how to use the OPC-UA server function (/E3 option).
	Model GX10/GX20/GP10/GP20/GM10 SLMP Communication (/E4) User's Manual	IM 04L51B01-21EN	Describes how to use SLMP communication function (/E4 option).

Model	Manual Title	Manual No.	Description
GX/GP GM	Model GX10/GX20/GP10/GP20/GM10/ GX90NW PROFINET Communication User's Manual	IM 04L51B01-22EN	Describes how to use PROFINET communication function.
	Model GX10/GX20/GP10/GP20/GM10 Loop Control Function, Program Control Function (/PG) User's Manual	IM 04L51B01-31EN	Describes how to use the PID control function and program control (/PG option) function.
GX/GP	DXA170 DAQStudio User's Manual	IM 04L41B01-62EN	Describes how to create custom displays (/CG option).

Notes

- The contents of this manual are subject to change without prior notice as a result of continuing improvements to the instrument's performance and functions.
- Every effort has been made in the preparation of this manual to ensure the accuracy of its contents. However, should you have any questions or find any errors, please contact your nearest YOKOGAWA dealer.
- Copying or reproducing all or any part of the contents of this manual without YOKOGAWA's permission is strictly prohibited.

QR Code

The product has a QR Code pasted for efficient plant maintenance work and asset information management.

It enables confirming the specifications of purchased products and user's manuals. For more details, please refer to the following URL.

<https://www.yokogawa.com/qr-code>

QR Code is a registered trademark of DENSO WAVE INCORPORATED.

Trademarks

- SMARTDAC+ is a registered trademark or trademark of Yokogawa Electric Corporation.
- SLMP is a registered trademark of Mitsubishi Electric Corporation.
- Microsoft and Windows are registered trademarks or trademarks of Microsoft Corporation in the United States and other countries.
- Adobe and Acrobat are registered trademarks or trademarks of Adobe Systems Incorporated.
- Company and product names that appear in this manual are registered trademarks or trademarks of their respective holders.
- The company and product names used in this manual are not accompanied by the registered trademark or trademark symbols (® and ™).

About the Usage of Open Source Software







This product uses open source software.

For details on using open source software, see Regarding the Downloading and Installing for the Software, Manuals and Labels (IM 04L61B01-11EN).

Revisions

December 2015	1st Edition
June 2017	2nd Edition
May 2020	3rd Edition
May 2023	4th Edition

Conventions Used in This Manual

Unit	
K	Denotes 1024. Example: 768K (file size)
k	Denotes 1000.
Notes	
	<i>Improper handling or use can lead to injury to the user or damage to the instrument.</i> This symbol appears on the instrument to indicate that the user must refer to the user's manual for special instructions. The same symbol appears in the corresponding place in the user's manual to identify those instructions. In the manual, the symbol is used in conjunction with the word "WARNING" or "CAUTION."
Warning	Calls attention to actions or conditions that could cause serious or fatal injury to the user, and precautions that can be taken to prevent such occurrences.
CAUTION	Calls attention to actions or conditions that could cause light injury to the user or cause damage to the instrument or user's data, and precautions that can be taken to prevent such occurrences.
Note	Calls attention to information that is important for the proper operation of the instrument.
Reference Item	
	Reference to related operation or explanation is indicated after this mark. Example: ► section 4.1
Conventions Used in the Procedural Explanations	
Bold characters	Denotes key or character strings that appear on the screen. Example: Voltage
	Indicates the character types that can be used.
	Carry out the procedure according to the step numbers. All procedures are written with inexperienced users in mind; depending on the operation, not all steps need to be taken. Explanation gives information such as limitations related the procedure.
	
	Indicates the setup screen and explains the settings.
	

Recorder Version and Functions Described in This Manual

The contents of this manual apply to the GX/GP/GM10 with the following release number (see the STYLE S number) and later and style number (see the STYLE H number) and later.

Model	Release Number	Style Number
GX10	5	5
GP10		
GX20		3
GP20		4
GM10		1

Edition	Product	Description
1	GX/GP: Version 3.01 and later GM: Version 3.01 and later	—
2	GX/GP: Version 4.01 and later GM: Version 4.01 and later	Corresponds to release number 4 of GX/GP/GM.
3	GX/GP: Version 4.08 and later GM: Version 4.07 and later	Support for style up (H: 3 (GX10/GX20/GP10), H: 4 (GP20)) of GX/GP. —

Contents

- Introduction..... i
- Conventions Used in This Manual..... ii
- Recorder Version and Functions Described in This Manual..... iii
- Introduction of Features 1
 - SLMP Communication..... 1
 - What the GX, GP, and GM Can Do 1
- SLMP Communication (/E4) Specifications 2
- GX, GP, or GM Configuration 3
 - Configuring IP Address, Host Information, DNS, and Other Settings..... 3
 - Configuring the SLMP Client 3
- SLMP Communication Status Display 10
 - SLMP Communication Status Management..... 10
 - SLMP Communication Status Screen 11
 - SLMP Log Screen 14

Blank

Introduction of Features

SLMP Communication

The SLMP communication (/E4) of the GX, GP, and GM is a function for reading and writing data by connecting to an SLMP¹ server through Ethernet. The GX, GP, and GM are SLMP clients. The maximum number of connectable servers is 16.

- By using the GX/GP custom display function^{2,3}, you can read from and write to a server through touch operation (directly enter values).

- 1 SLMP stands for Seamless Message Protocol and is a protocol for communicating with SLMP devices from external devices.
- 2 An option (/CG) is required on the GX, GP.
- 3 Creating custom displays requires DAQStudio (DXA170) sold separately.

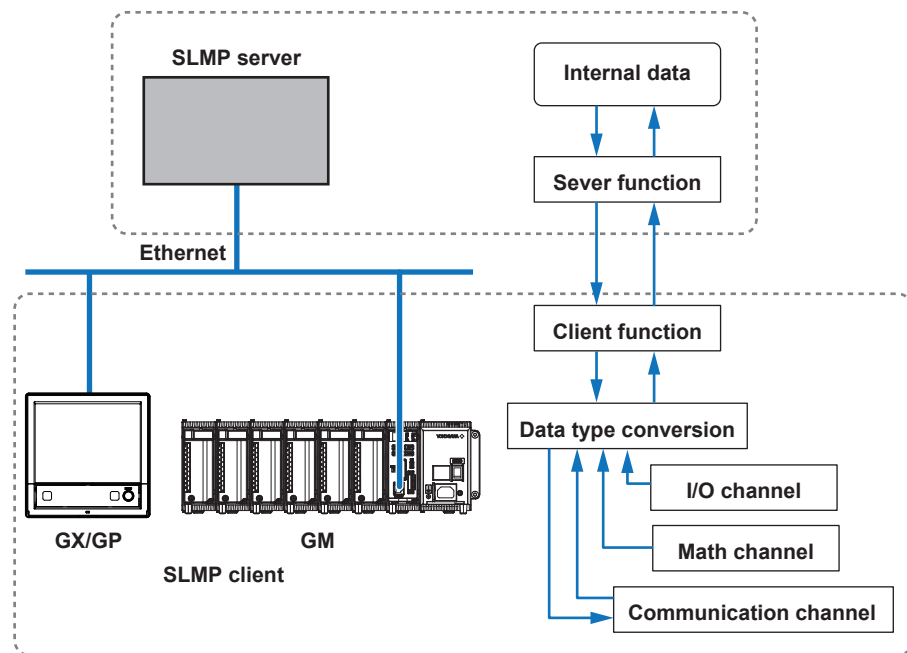

Note

For details on SLMP servers, see the materials provided with the server.

What the GX, GP, and GM Can Do

The GX, GP, and GM and provide the following functions.

- Data from SLMP servers can be read into the GX, GP, and GM communication channels.
- Data of the GX, GP, and GM's I/O channels, math channels,¹ and communication channels² can be written to SLMP servers.

Data	Access
I/O channel data	Write
Math channel ¹ data	Write
Communication channel ² data	Read/write

- 1 An option (/MT) is required on the GX, GP, and GM.
- 2 An option (/MC) is required on the GX, GP, and GM.

SLMP Communication (/E4) Specifications

Item	Description
Communication medium	Ethernet
Data code	Binary or ASCII
Frame format	3E
Read cycle	100 ms/200ms/500ms/1s/2s/5s/10s/20s/30s/1min
Application time out	250 ms/500ms/1s/2s/3s/4s/5s/10s/20s/30s/1min
Recovery time	Off/5s/10s/30s/1min/2min/5min
Number of server connections	Up to 16
Command types	Off/Read/Write
Maximum number of command registrations	GX10/GP10: 50 GX20-1/GP20-1/GM10-1: 100 GX20-2/GP20-2/GM10-2: 200

Connecting to a Network

Connect an Ethernet cable to the Ethernet port of the GX, GP, or GM.

Do not use an Ethernet cable whose plug does not comply with FCC specifications. Doing so can cause a malfunction.

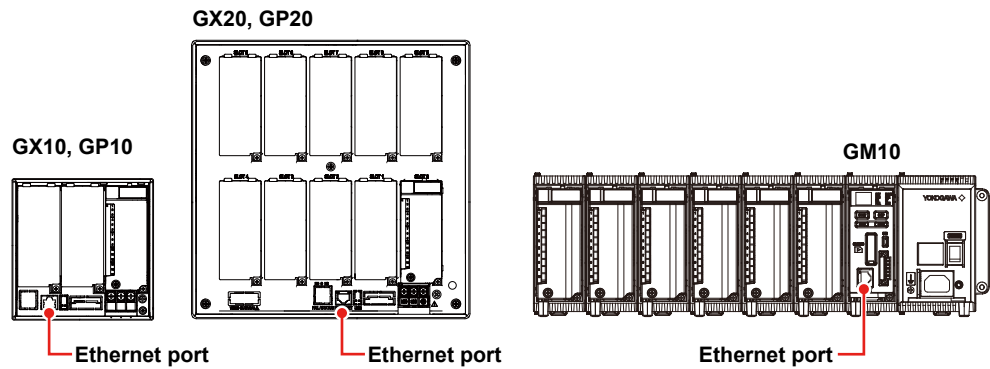

GX, GP, or GM Configuration

Configure the following to prepare the GX, GP, or GM.

- IP address and other settings for connecting to Ethernet
- SLMP client basic settings
- SLMP server settings
- SLMP client command settings

Configuring IP Address, Host Information, DNS, and Other Settings

- ▶ GX/GP: See section 1.17, “Configuring the Ethernet Communication Function,” in the User’s Manual (IM 04L51B01-01EN).
- ▶ GM: See section 2.18, “Configuring the Ethernet Communication Function,” in the User’s Manual (IM 04L55B01-01EN).

Configuring the SLMP Client

Basic Settings

Path

GX/GP: **MENU** key > **Browse** tab > **Setting** > Setting menu **Communication (Ethernet) settings** > **SLMP client settings** > **Basic settings**

Web application: **Config.** tab > **Communication (Ethernet) settings** > **SLMP client basic settings**

Hardware configurator: **Communication (Ethernet) settings** > **SLMP client basic settings**

Description

SLMP client function

Setup Item	Selectable Range or Options	Default Value
On/Off	Off/On	Off

On/Off

Set to On to enable the SLMP client function.

Data code*

Setup Item	Selectable Range or Options	Default Value
Data code	Binary or ASCII	Binary

* You can set this when the SLMP client function is set to **On**.

Data code

Data code for communicating with the SLMP server. Set this the same as the SLMP server.

Communication*

Setup Item	Selectable Range or Options	Default Value
Interval	100 ms/200ms/500ms/1s/2s/5s/10s/20s/30s/1min	1s

* You can set this when the SLMP client function is set to **On**.

Interval

Set the interval for communicating with the SLMP server.

Connection*

Setup Item	Selectable Range or Options	Default Value
Communication timeout*	250 ms/500ms/1s/2s/3s/4s/5s/10s/20s/30s/1min	4s

* You can set this when the SLMP client function is set to **On**.

Communication timeout*

Set the communication timeout value.

Recovery action*

Setup Item	Selectable Range or Options	Default Value
Recovery time	Off/5s/10s/30s/1min/2min/5min	2 min

* You can set this when the SLMP client function is set to **On**.

Recovery time

Set the auto recovery time from communication halt.

Connection Destination Server

Path

GX/GP: **MENU** key > **Browse** tab > **Setting** > Setting menu **Communication (Ethernet) settings** > **SLMP client settings** > **SLMP server settings**

Web application: **Config.** tab > **Communication (Ethernet) settings** > **SLMP server settings**

Hardware configurator: **Communication (Ethernet) settings** > **SLMP server settings**

Description

SLMP server settings

Setup Item	Selectable Range or Options	Default Value
Server number	1 to 16	—
Server name	Up to 64 characters	—
Port number	0 to 65535	1025

Server number

Set the connection destination server number.

Server name

Set the name of the server to communicate with.

If the DNS is available, you can set the host name as a server name. You can also set the IP address.

Port number

Set the port number set on the destination server.

Command settings

Path

GX/GP: **MENU** key > **Browse** tab > **Setting** > Setting menu **Communication (Ethernet) settings** > **SLMP client settings** > **Command settings**

Web application: **Config.** tab > **Communication (Ethernet) settings** > **SLMP client command settings** > Client command number range (display example: 1-20)

Hardware configurator: **Communication (Ethernet) settings** > **SLMP client command settings** > Client command number range (display example: 1-20)

Description

Command settings

Setup Item	Selectable Range or Options	Default Value
Client command number	GX10/GP10: 1 to 50 GX20-1/GP20-1/GM10-1: 1 to 100 GX20-2/GP20-2/GM10-2: 1 to 200	1
Type	Off/Read/Write	Off
Server ¹	1 to 16	1
Request dest network No. ¹	0 to 255 (enter using hexadecimal notation)	0
Request dest station No. ¹	0 to 255 (enter using hexadecimal notation)	255 (FF)
Request dest module I/O No. ¹	0 to 65535 (enter using hexadecimal notation)	1023 (3FF)
Request dest multidrop station No. ¹	0 to 31 (enter using hexadecimal notation)	0
Device code ¹	See the device code table.	M
Head device number ¹	0 to 16777215 (enter using hexadecimal notation)	0
Data type ¹	BIT/INT16/UINT16/INT32/UINT32/FLOAT	INT16
Channel type ¹	I/O channel, Math channel, ² Communication channel ³	—
First-CH ¹	Valid channel range	—
Last-CH ¹	Valid channel range	—

¹ You can set this when the type not set to **Off**.

² An option (/MT) is required on the GX, GP, and GM.

³ An option (/MC) is required on the GX, GP, and GM.

Client command number

Set the client command number.

Type

Set the command type.

Server

Set the communication destination server number.

Request dest network No.

Set the request destination network number set on the destination server (hexadecimal input).

Request dest station No.

Set the station number set on the destination server (hexadecimal input).

Request dest module I/O No.

Set the request destination module I/O number set on the destination server (hexadecimal input).

Request dest multidrop station No.

Set the request destination module station number set on the destination server (hexadecimal input).

Device code

Set the device code for read and write commands.

Device		Device Code	Data Type Options
Special relay		SM	BIT
Special register		SD	INT16/UINT16/INT32/UINT32/FLOAT
Input		X	BIT
Output		Y	BIT
Internal relay		M	BIT
Latch relay		L	BIT
Annunciator		F	BIT
Edge relay		V	BIT
Link relay		B	BIT
Data register		D	INT16/UINT16/INT32/UINT32/FLOAT
Link register		W	INT16/UINT16/INT32/UINT32/FLOAT
Timer	Contact	TS	BIT
	Coil	TC	BIT
	Current value	TN	INT16/UINT16/INT32/UINT32/FLOAT
Integration timer	Contact	SS	BIT
	Coil	SC	BIT
	Current value	SN	INT16/UINT16/INT32/UINT32/FLOAT
Counter	Contact	CS	BIT
	Coil	CC	BIT
	Current value	CN	INT16/UINT16/INT32/UINT32/FLOAT
Special link relay		SB	BIT
Special link register		SW	INT16/UINT16/INT32/UINT32/FLOAT
Direct access input		DX	BIT
Direct access output		DY	BIT
Index register		Z	INT16/UINT16/INT32/UINT32/FLOAT
File register		R	INT16/UINT16/INT32/UINT32/FLOAT
		ZR	
Extended data register		D	INT16/UINT16/INT32/UINT32/FLOAT
Extended link register		W	

Head device number

Set the head device number for read and write commands (hexadecimal input).

Data type

Set the data type for read and write commands.

Data Type	Description
INT16	16-bit signed integer
UINT16	16-bit unsigned integer
INT32	32-bit signed integer
UINT32	32-bit unsigned integer
FLOAT	32-bit floating point
BIT	Bit

Channel type

Set the channel type of the GX, GP, or GM for reading and writing.

First-CH

Set the first channel of the GX, GP, or GM for reading and writing.

Last-CH

Set the last channel of the GX, GP, or GM for reading and writing.

Command types	Data Type	Setting Range	Settable Channels	Maximum Number of Settable Channels
Read	BIT/INT16/ UINT16	0x0 to 0xFFFFFFFF (0 to 16777215)	GX10/GP10: C001 to C050 ¹ GX20-1/GP20-1/GM10-1: C001 to C300 ¹	200 Uses one head device number per channel
	INT32/UINT32/ FLOAT	0x0 to 0xFFFFFE (0 to 16777214)	GX20-2/GP20-2/GM10-2: C001 to C500 ¹	100 Uses two head device numbers per channel
Write	BIT/INT16/ UINT16	0x0 to 0xFFFFFFFF (0 to 16777215)	GX10/GP10: 0001 to 6932 A001 to A050 ² C001 to C050 ¹ GX20-1/GP20-1/GM10-1: 0001 to 6932 A001 to A100 ²	200 Uses one head device number per channel
	INT32/UINT32/ FLOAT	0x0 to 0xFFFFFE (0 to 16777214)	GX20-2/GP20-2/GM10-2: 0001 to 6932 A001 to A200 ² C001 to C500 ¹	100 Uses two head device numbers per channel

¹ An option (/MC) is required on the GX, GP, and GM.

² An option (/MT) is required on the GX, GP, and GM.

Examples of Setting Commands

Connection Example
Recorder
(SLMP client)

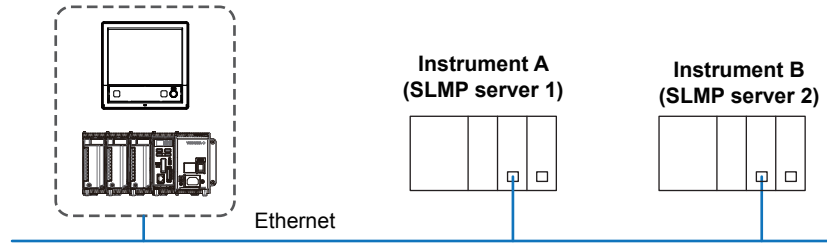

Example 1

Read the data register D0123 of instrument A into communication channel C001.



Command settings

Setup Item	Value
Client command number	1
Command settings	Type Read
	Server 1
	Request dest network No. 0x0 (0)
	Request dest station No. 0xFF (255)
	Request dest module I/O No. 0x3FF (1023)
	Request dest multidrop station No. 0x0 (0)
	Device Code D
	Head device number 0x7B (123)
	Data Type INT16
	Channel type Communication channel
	First-CH C001
	Last-CH C001

Example 2

Read data registers D1234 and D1235 of instrument A into communication channels C002.



Command settings

Setup Item	Value
Client command number	2
Command settings	Type Read
	Server 1
	Request dest network No. 0x0 (0)
	Request dest station No. 0xFF (255)
	Request dest module I/O No. 0x3FF (1023)
	Request dest multidrop station No. 0x0 (0)
	Device Code D
	Head device number 0X4D2 (1234)
	Data Type INT32
	Channel type Communication channel
	First-CH C002
	Last-CH C002

Example 3

Write the measured value of I/O channel 3005 to data register D2345 of instrument B.

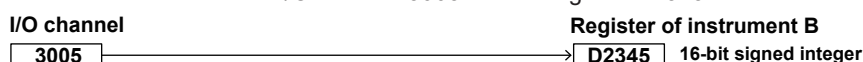
**Command settings**

Setup Item	Value
Client command number	3
Command settings	Type Write
	Server 2
	Request dest network No. 0x0 (0)
	Request dest station No. 0xFF (255)
	Request dest module I/O No. 0x3FF (1023)
	Request dest multidrop station No. 0x0 (0)
	Device Code D
	Head device number 0x929 (2345)
	Data Type INT16
	Channel type I/O channel
	First-CH 3005
	Last-CH 3005

Example 4 (GX/GP only)

Write from a digital operation component of a custom display (/CG option) to data register D3456 of device B.

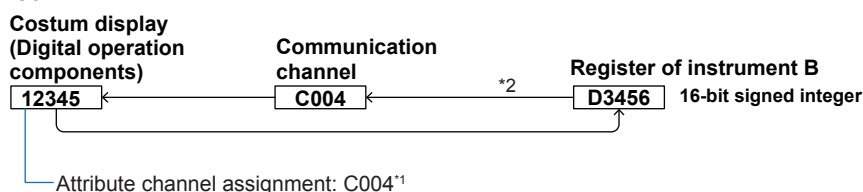

- When writing, the channel assigned to the component attribute (C004) and the SLMP command information in which the channel is registered are used to determine the write destination device and device number. From the custom display, values are written directly without going through the communication channel.
- When reading, data is read through the communication channel (C004) according to the specified command setting, and the data is shown on the custom display.

Command settings

Setup Item	Value
Client command number	4
Command settings	Type Read *2
	Server 2
	Request dest network No. 0x0 (0)
	Request dest station No. 0xFF (255)
	Request dest module I/O No. 0x3FF (1023)
	Request dest multidrop station No. 0x0 (0)
	Device Code D
	Head device number 0xD80 (3456)
	Data Type INT16
	Channel type Communication channel
	First-CH C004
	Last-CH C004





*1 Setting custom display attributes requires DAQStudio (DXA170) sold separately.

*2 When writing values from the custom display, because values are read into a communication channel, the command setting type must be set to "Read."

SLMP Communication Status Display

SLMP Communication Status Management

Status LED States

Status LED	State	Description
 (blue)	ACTIVE (Normal data acquisition)	Communication has been successfully established and normal data has been acquired.
 (yellow)	READY (Data being requested)	Communication has been successfully established but normal data has not been acquired.
 (orange)	CLOSE (Connected)	TCP connection in progress.
 (red)	HALT (Communication failure)	Communication has failed and has entered a communication recovery wait state

State Transition

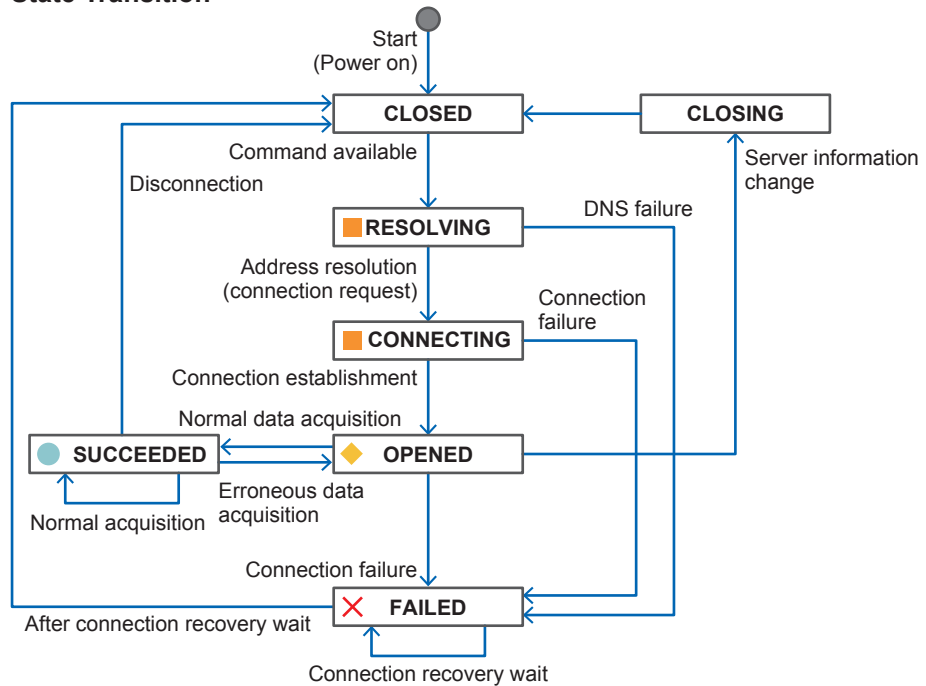

SLMP Client State

State	Description
SUCCEEDED	Data was successfully acquired (normal communication in progress).
OPEND	Connection is open (message communication possible)
CLOSED	Connection is closed (connection not requested)
FAILED	Connection failed (connection recovery wait state)
RESOLVING	Address being resolved (DNS query in progress)
CONNECTING	Connection request in progress (requesting TCP connection establishment)
CLOSING	Connection is being disconnected (requesting TCP disconnection)

SLMP Communication Status Screen

You can check the communication status of the SLMP client.
Two display modes are available on the GX/GP: list mode and overview mode.

Procedure

Displaying the SLMP Communication Status Screen

GX/GP: **MENU** key > **Browse** tab > **SLMP client**^{*}
Web application: **Data** tab > **SLMP client**^{*}

^{*} Appears when the SLMP client function is set to On.

Switching between List Mode and Overview Mode (GX/GP only)

GX/GP: **MENU** key > **Context** tab > **Display Overview/List**

Explanation

List Mode Display of the SLMP Communication Status Screen

This is a display example on the GX/GP.

Tap a command to display the SLMP information.

NO	Status	Comm.Data		Server name	Device	
		First	Last		code	no.
1	W INVALID	A001	- A100	192.168.1.10	SD	0x0
2	R NO_DATA	C001	- C100	192.168.1.10	X	0x0
3	W WAITING	0001	- 0100	192.168.1.10	Y	0x0
4	R CLOSED	A001	- A100	192.168.1.10	M	0x0
5	W RESOLVING	C001	- C100	192.168.1.10	L	0x0
6	R CONNECTING	0001	- 0100	192.168.1.10	F	0x0
7	W UNREACH	A001	- A100	192.168.1.10	V	0x0
8	R TIMEDOUT	C001	- C100	192.168.1.10	B	0x0
9	W ERROR	0001	- 0100	192.168.1.10	D	0x0
10	R BROKEN	A001	- A100	192.168.1.10	W	0x0

Overview Mode Display of the SLMP Communication Status Screen (GX/GP only)

This is a display example on the GX/GP. Command numbers are displayed. The background color of each command number corresponds to the communication status (see "Status LED States").

Tap a command to display the SLMP information.

1	11	21
2	12	22
3	13	23
4	14	24
5	15	25
6	16	26
7	17	27
8	18	28
9	19	29
10	20	30

Web Application of the SLMP Communication Status Screen

Like the GX/GP screen, communication conditions and command information are displayed.

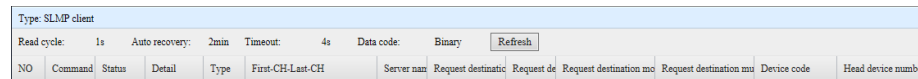

SLMP Information

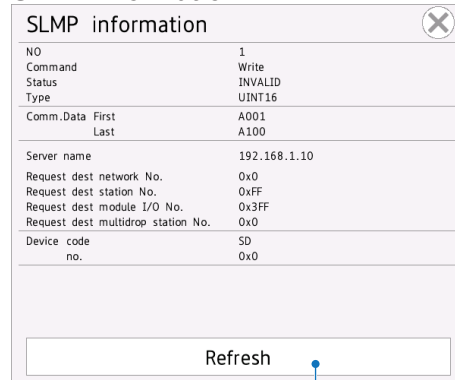

Executes manual server recovery

Communication Conditions

Item	Description
Scroll icon ¹ (UP/DOWN)	Used to scroll the command area. This is unavailable in overview mode. ¹
Read cycle	The SLMP client's read cycle.
Time out	Timeout value of a single command.
Auto recovery	Auto recovery time for communication errors.
Data code	Binary or ASCII
Loop time ¹	The execution time of all commands. (Displayed in red during a dropout)
Command dropout icon	Appears when a data dropout occurs. The icon remains displayed until you tap it. The command execution time is displayed in red while the icon is displayed.

1 Displayed only on the GX/GP

Command Information and SLMP Information

Item	Description
NO	Displays the client command number.
State	Displays the command type (R (read)/W (write)). Displays the communication status (communication status icon and details). (See "SLMP Communication Details.")
Type	Displays the data type.
First-Last	Displays the first and last channels for reading and writing.
Server name	Displays the connection destination server name.
Request dest network No.	Displays the connection destination network number.
Request dest station No.	Displays the connection destination station number.
Request dest module I/O No.	Displays the connection destination I/O number.
Request dest multidrop station No.	Displays the connection destination multidrop station number.
Device code	Displays the device code.
Head device number	Displays the head device number.

Command Dropout Icon (data dropout occurrence)

The command dropout icon of the SLMP communication status screen appears when a dropout occurs. In this situation, the command execution time is displayed in red.

- Tapping (clicking) the icon clears the icon. If another data dropout occurs, the icon will reappear.

Data drop occurs when the commands from 1 to 100 from the GX20-1/GP20-1/GM10-1, from 1 to 200 from the GX20-2/GP20-2/GM10-2, or from 1 to 50 from the GX10/GP10 do not complete within the read cycle. When a data dropout occurs, the communication channel data is held at the previous value.

- If this happens, take measures such as making the read cycle longer or reducing the number of commands. Confirm that no data dropout occurs on the SLMP log screen.

Refresh Button

You can execute manual recovery on a server to which communication is stopped (red status lamp).

- Tapping (clicking) the Refresh button executes manual recovery on the server.

You may not be able to use the Refresh button depending on the security setting.

Security Setting	Condition
Operation lock	Limitation item Communication is set to Lock and Operation Lock is set to Lock
Login	<ul style="list-style-type: none"> • Logged out • User property Communication is set to Lock and that user is logged in • Logged in as a monitor user (when using advanced security, /AS)

Overview Mode Arrangement

The arrangements depending on the number of commands are shown below.

GX20/GP20

Number of Commands	Row	Column
1	1	1
2	2	1
3 and 4	2	2
5 and 6	3	2
7 and 8	4	2
9 and 10	5	2
11 and 12	6	2
13 and 14	7	2
15 and 16	8	2
17 and 18	9	2
19 and 20	10	2
21 to 30		3
31 to 40		4
41 to 50		5
51 to 60		6
61 to 70		7
71 to 80		8
81 to 90		9
91 to 100		10
101 to 110		11
111 to 120		12
121 to 130		13
131 to 140		14
141 to 150		15
151 to 160		16
161 to 170		17
171 to 180		18
181 to 190		19
191 to 200		20

GX10/GP10

Number of Commands	Row	Column
1	1	1
2	2	1
3 and 4	2	2
5 and 6	3	2
7 and 8	4	2
9 and 10	5	2
11 to 15		3
16 to 20		4
21 to 26		5
31 to 36		6
36 to 41		7
41 to 30		8
31 to 40		9
41 to 50		10

Number of commands 101 and higher are for GX20-2/GP20-2 only.

SLMP Communication Details

Group	Status	Description
Communication status	START	SLMP communication was started.
	STOP	SLMP communication was stopped.
	DROPOUT	All commands cannot be processed within the specified read cycle. (Review the number of commands and the read cycle setting.)
Command problem	SKIP	Command not set.
	INVALID	Command cannot be executed.
Communication problem	WAITING	Server communication recovery wait
	CLOSED	SLMP communication is stopped and connection to the server is closed.
	RESOVING	Server connection is being established (resolving address).
	CONNECTING	Server connection being established (requesting connection)
	UNREACH	Server connection failed (server not found).
	TIMEDOUT	Server connection failed (timeout occurred).
Response problem	ERROR	System error occurred.
	BROKEN	Response message is corrupt.
	BAD HEAD	Response message header error
	BAD LEN	Response message size error
	BAD DATA	Response message data error
	ERR ****	Error response was received (****: error number)
	NO_DATA	Data has not yet been received once. (Check the communication settings.)
Data condition	VALID	Data is being acquired normally.
	STALE	Data is old.

SLMP Log Screen

Procedure

GX/GP: **MENU** key > **Browse** tab > **Log** > **SLMP**
 Web application: **Data** tab > **Log** > **SLMP Log**

Explanation

SLMP Log

Item	Description	
Time	The time when the communication log was recorded.	
Factor/Detail	Communication status icon	
	Blue ●: ACTIVE	Communication has been successfully established and normal data has been acquired.
	Yellow ◆: READY	Communication has been successfully established but normal data has not been acquired.
	Orange ■: CLOSE	TCP connection in progress.
	Red ✕: HALT	Communication has failed and has entered a communication recovery wait state
Communication status string	See "SLMP Communication Details."	
Command	Command number	The client command number.
	Command type	
	R (Read)	Read command
	W (Write)	Write command
	O	Immediate write command
N	Others	

Note

The yellow icon display is the error code returned from the connected device side. Refer to the manual of the connected device.